

UAP-nanoHD Quick Start Guide

Package Contents



UniFi nanoHD AP



Mounting Bracket

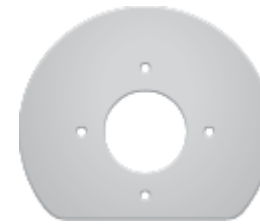

Ceiling Backing Plate



Screws (Qty. 4)



Flat Head Screws (Qty. 4)



Keps Nuts (Qty. 4)





UAP-nanoHD Quick Start Guide

INSTALLATION

** Included only in the single-pack of the UAP-nanoHD.*

Installation Requirements

- CAT5 cable
- Phillips screwdriver
- Drill and drill bit (6 mm for wall-mounting or 3 mm for ceiling-mounting)
- Optional: Drywall or keyhole saw (to cut 18 mm hole for Ethernet cable feed)



IMPORTANT: The UAP-nanoHD requires the UniFi Controller v5.7 or higher, available at: ui.com/download/unifi

System Requirements

- Microsoft Windows 7/8/10, Mac OS X, or Linux
- Java Runtime Environment 1.8 (or above)
- Web Browser: Google Chrome (Other browsers may have limited functionality.)
- UniFi Controller software v5.7 or higher (available at: ui.com/download/unifi)

Hardware Overview

LED

Ports

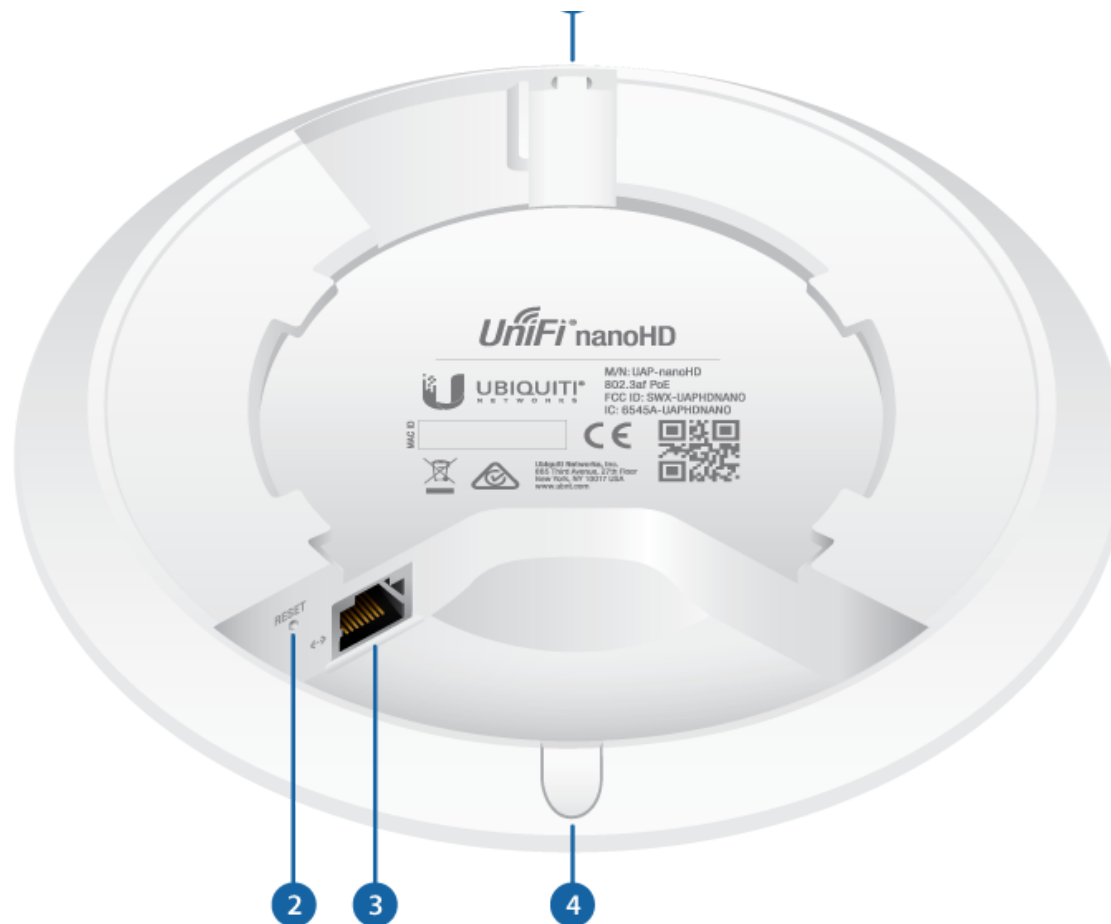

UAP-nanoHD Quick Start Guide

**1 Locking Notch**

The Locking Notch will be used with the Mounting Bracket to help secure the UniFi AP. (This is described further in the Mounting Bracket section.)

2 Reset

The Reset button serves two functions for the UniFi AP:



UAP-nanoHD Quick Start Guide

seconds.

3 Ethernet

This Gigabit Ethernet port is used to connect the power and should be connected to the LAN and DHCP server.

4 Cable Feed Plug

If your Ethernet cable feeds along the mounting surface, remove the Cable Feed Plug.

Mounting Bracket



UAP-nanoHD Quick Start Guide

**5 Locking Tab**

During installation, the Locking Tab on the Mounting Bracket moves from the Initial Position to the Final Position, where the Locking Tab fits securely into the Locking Notch on the UniFi AP to help prevent theft.

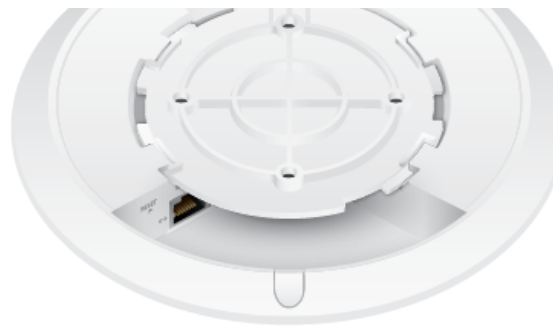

UAP-nanoHD Quick Start Guide

*Initial Position**Final Position*

Note: If you need to remove the UniFi AP from the Mounting Bracket, insert a paper clip in the Slot to release the Locking Tab and turn the UniFi AP counterclockwise.

Hardware Installation

The device can be mounted on the wall or ceiling. Perform the steps for the appropriate installation.

Wall Mount

- 1.



UAP-nanoHD Quick Start Guide

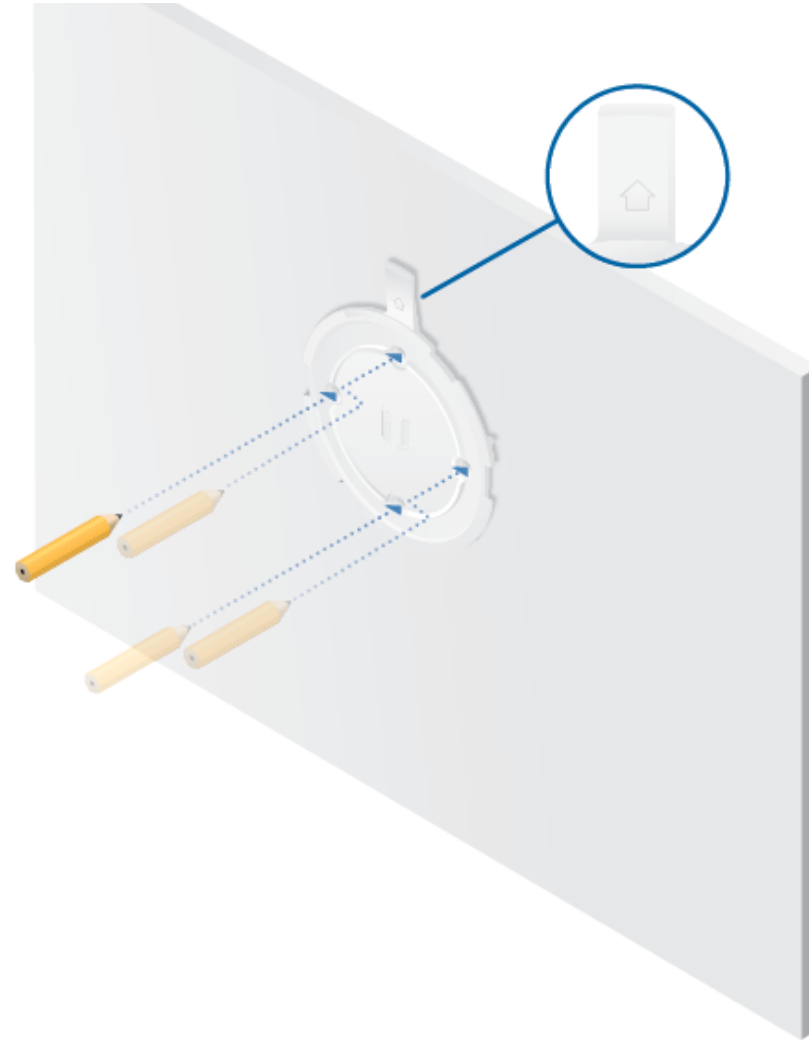

2.



UAP-nanoHD Quick Start Guide

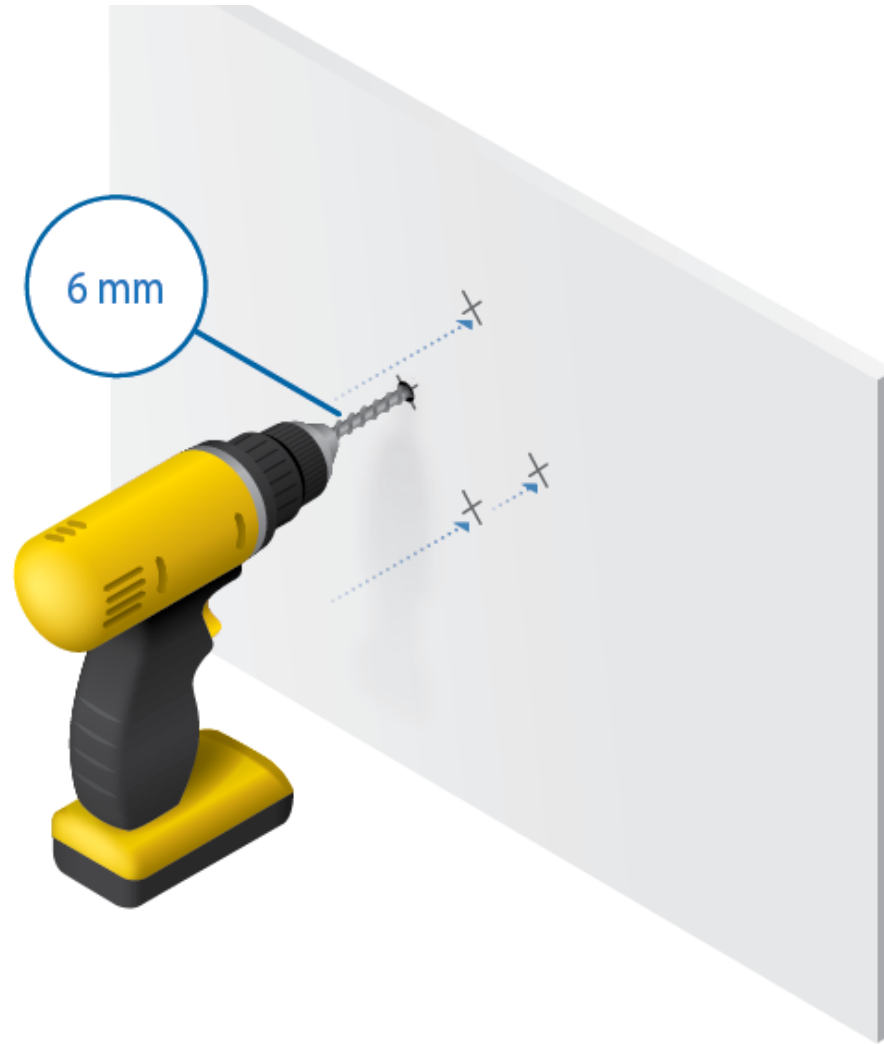

Optional



UAP-nanoHD Quick Start Guide

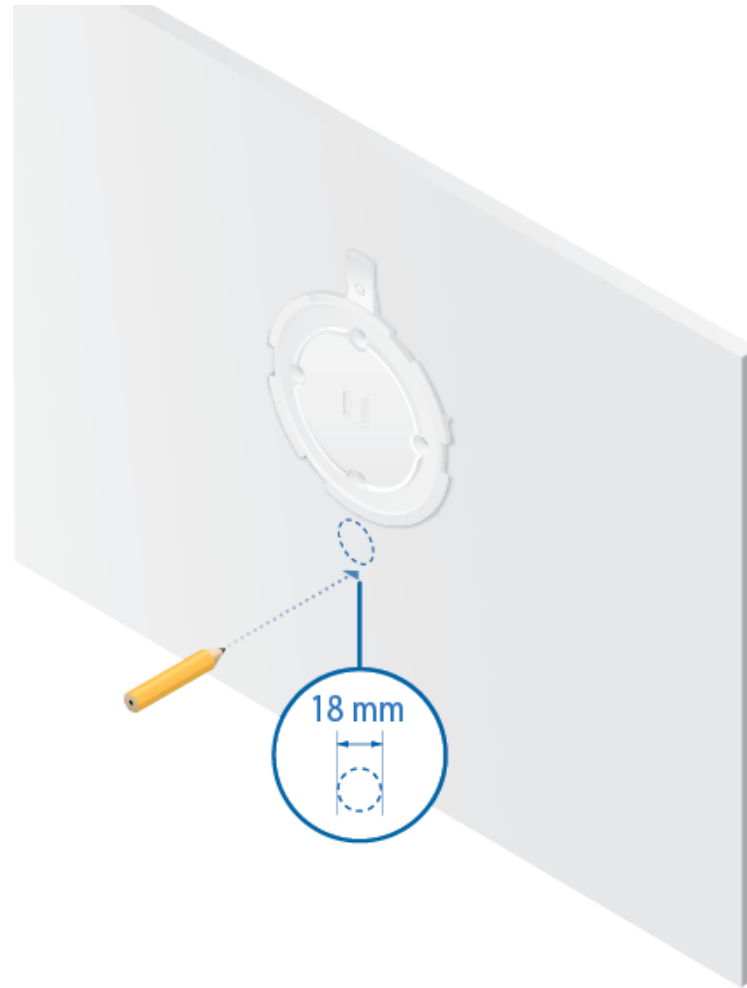



UAP-nanoHD Quick Start Guide



3.



UAP-nanoHD Quick Start Guide

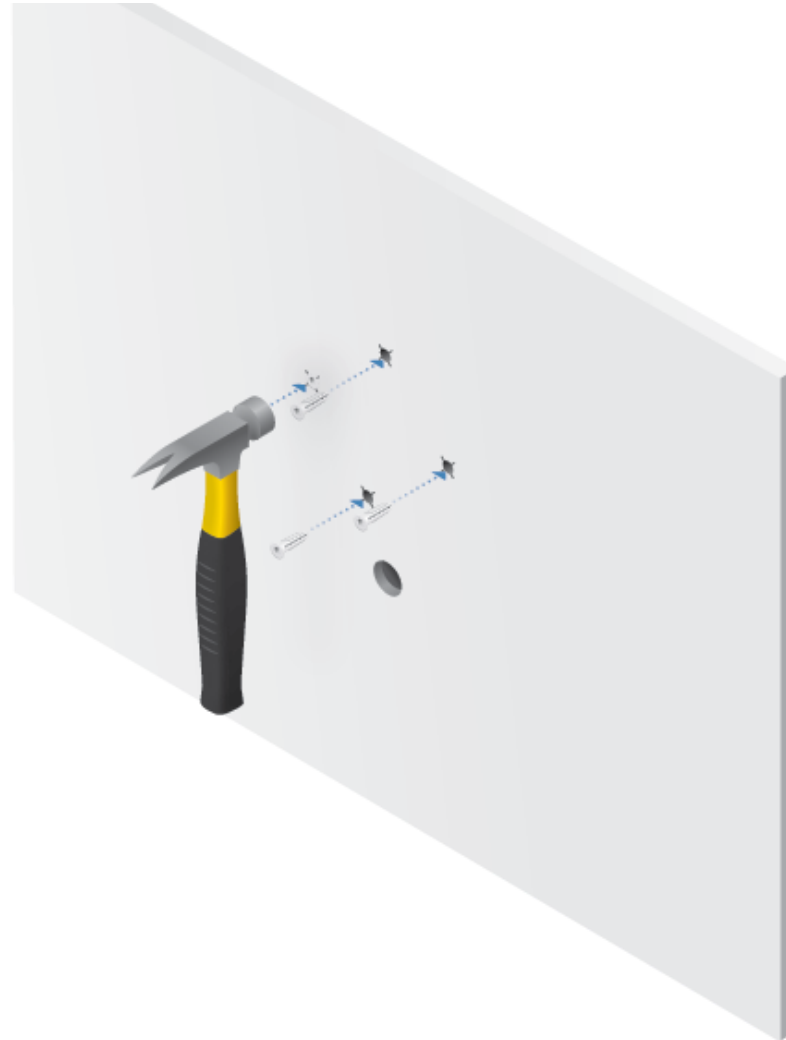

4.



UAP-nanoHD Quick Start Guide

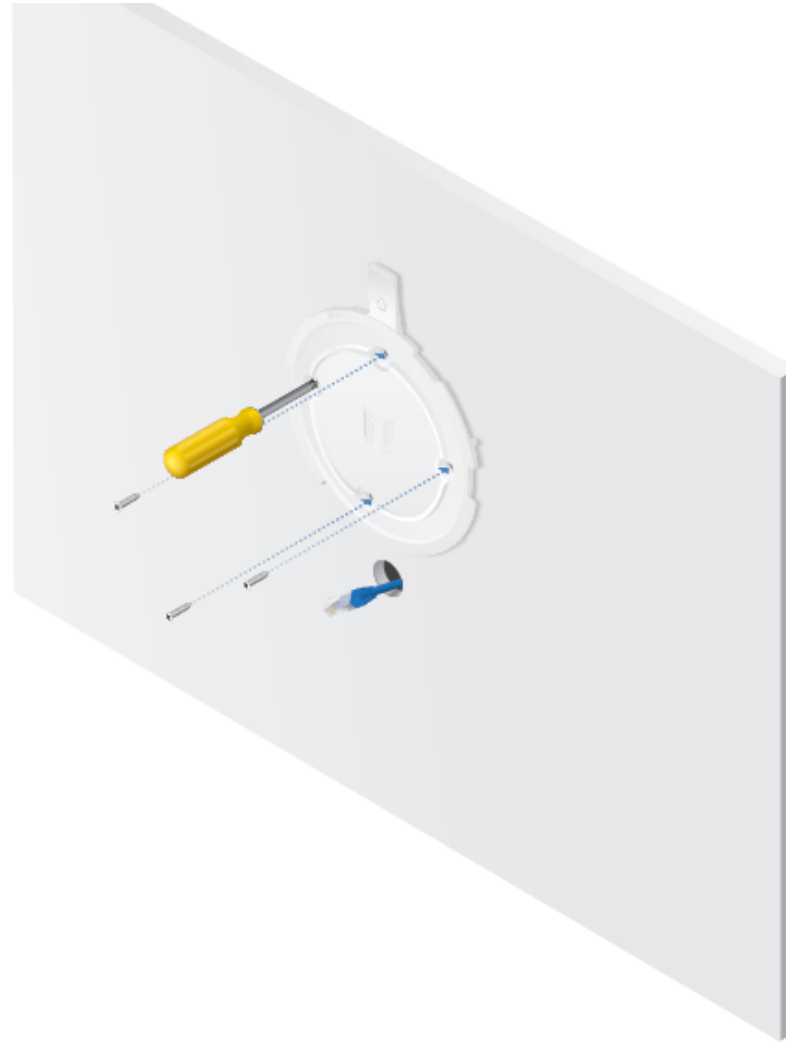

Optional



UAP-nanoHD Quick Start Guide

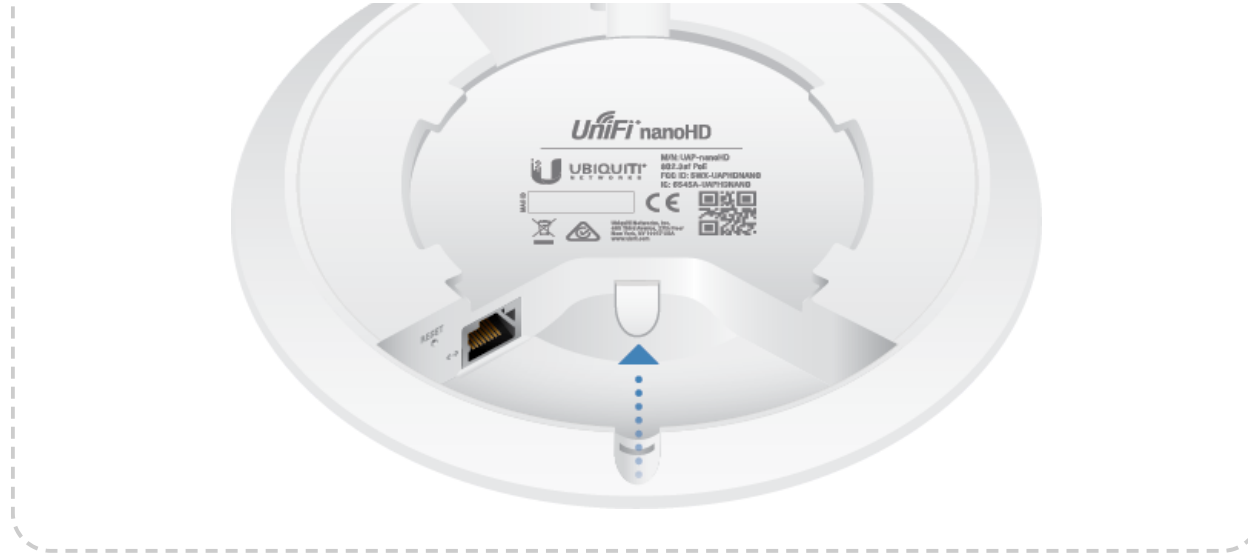

5.



UAP-nanoHD Quick Start Guide



6.



UAP-nanoHD Quick Start Guide

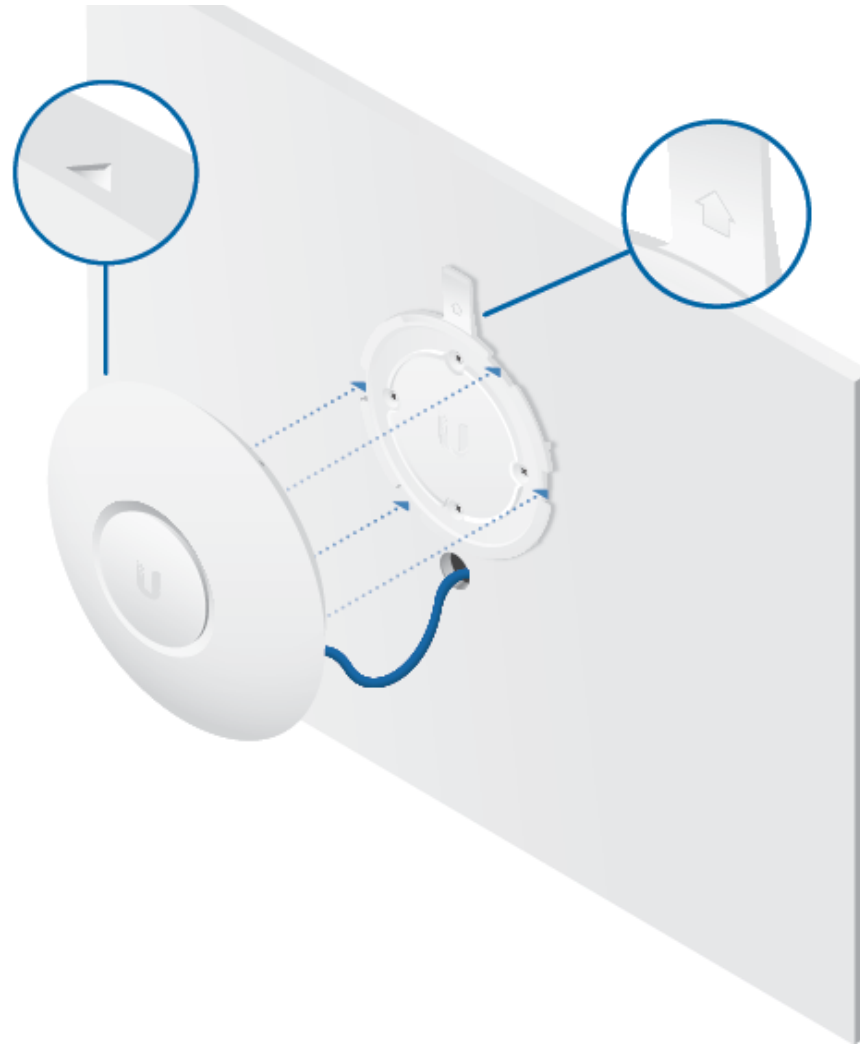

7.



UAP-nanoHD Quick Start Guide

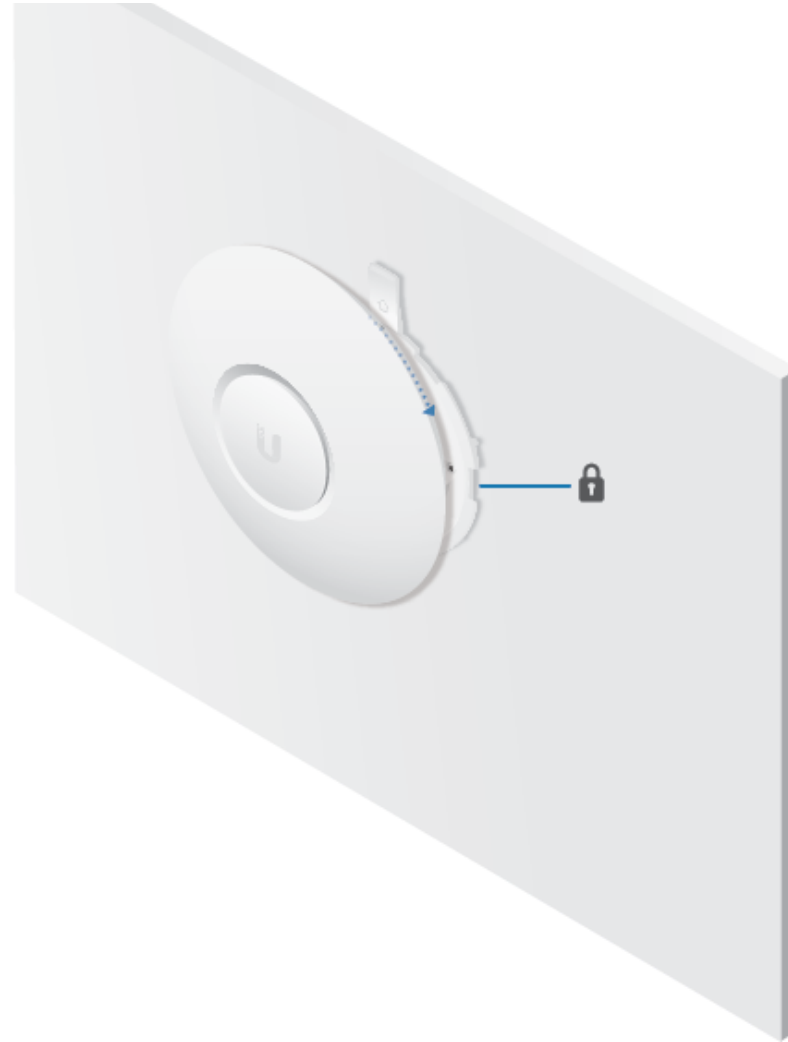

Ceiling Mount

1.



UAP-nanoHD Quick Start Guide

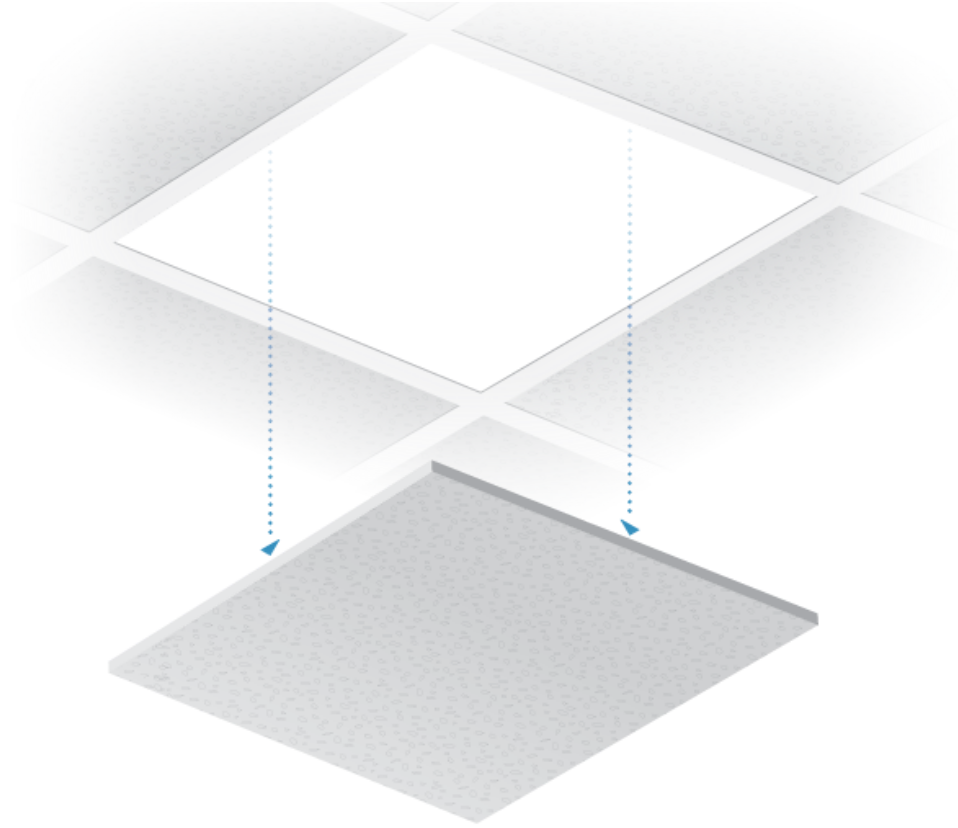

2.



UAP-nanoHD Quick Start Guide

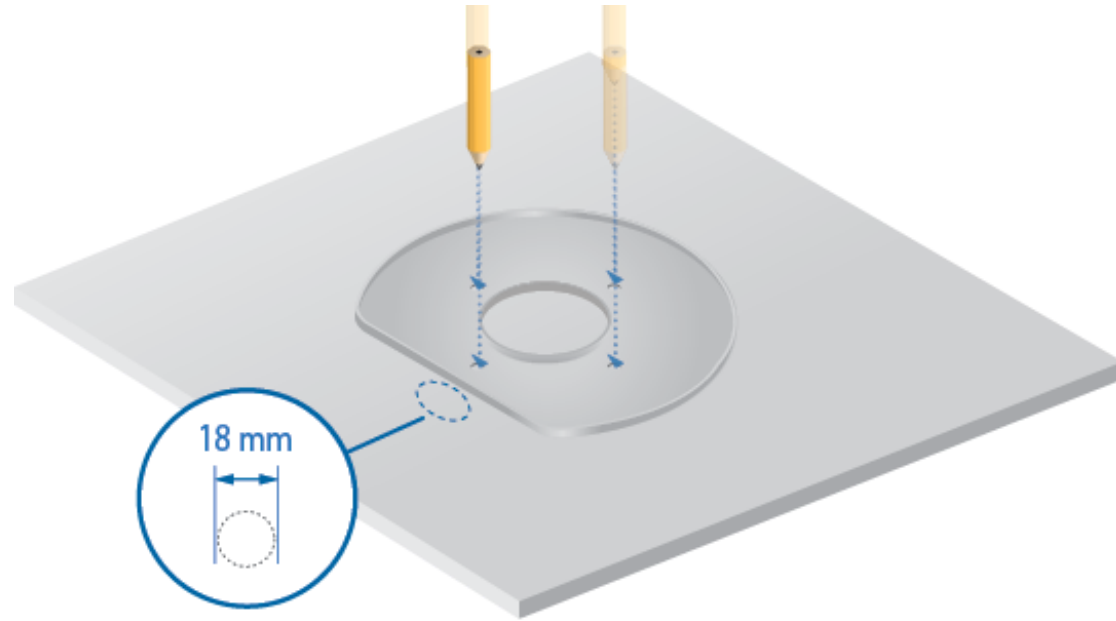

3.



UAP-nanoHD Quick Start Guide

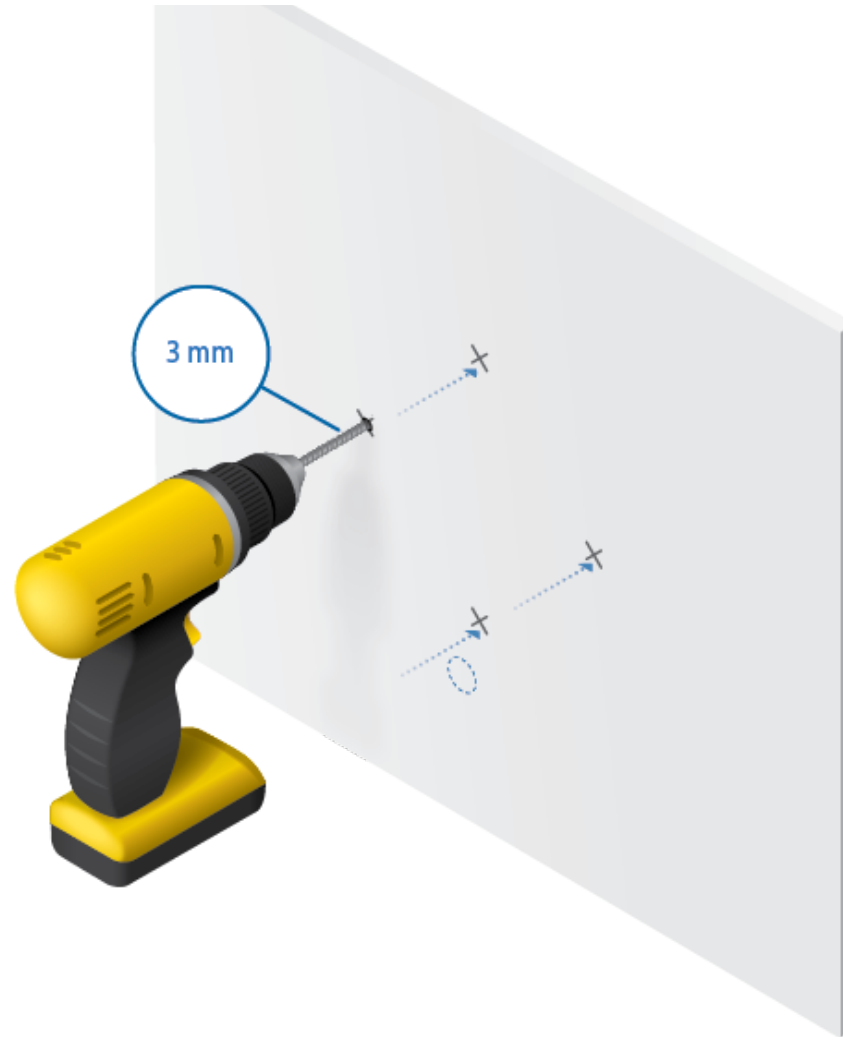

4.



UAP-nanoHD Quick Start Guide

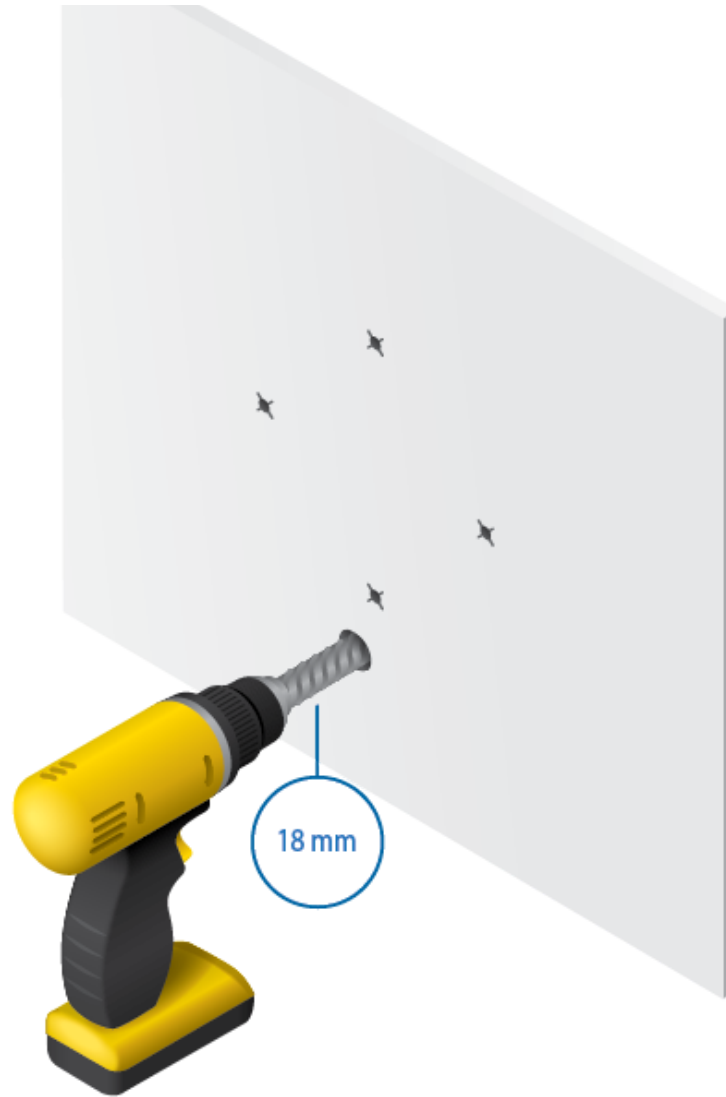

5.



UAP-nanoHD Quick Start Guide

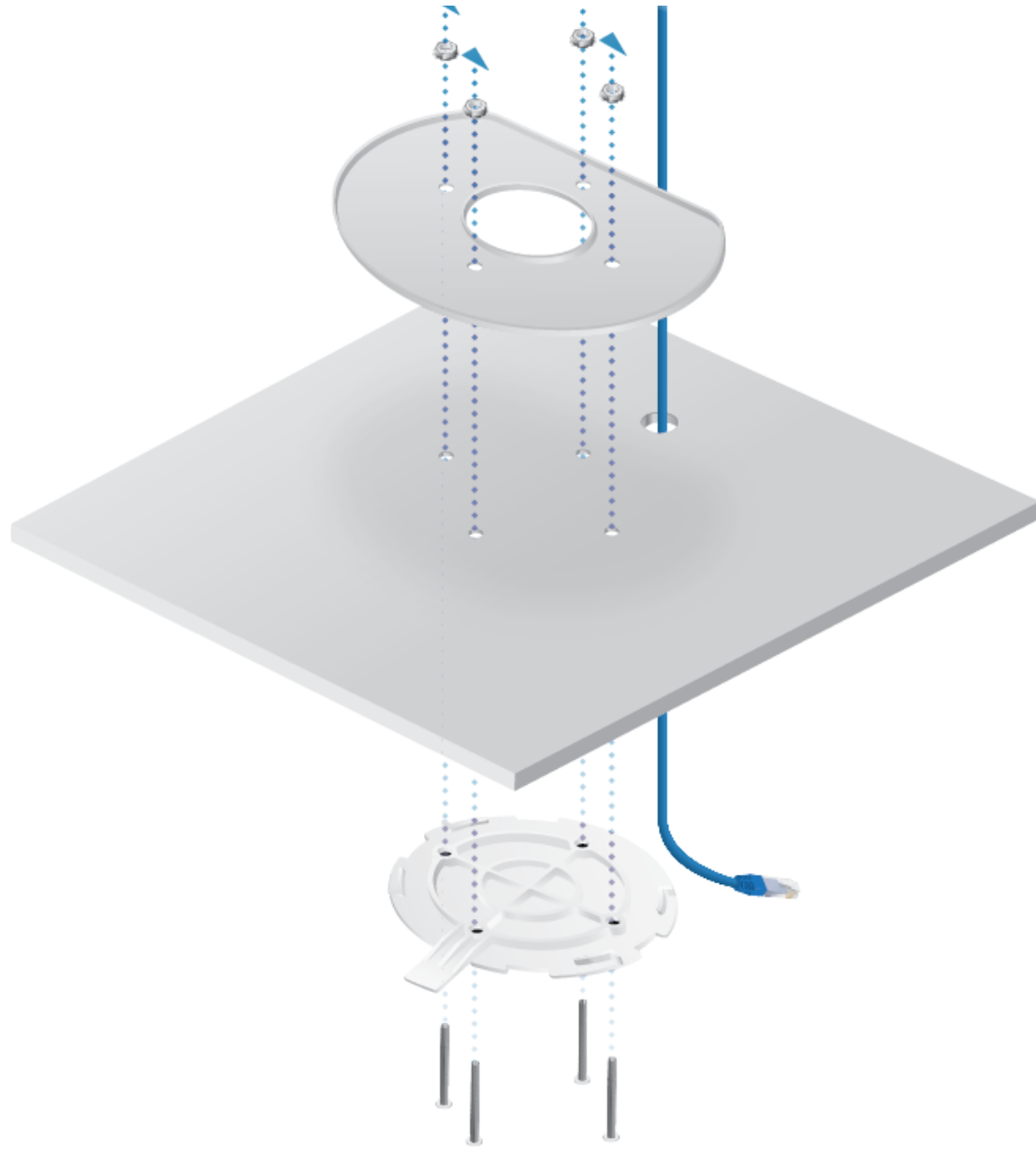

6.



UAP-nanoHD Quick Start Guide



7.



UAP-nanoHD Quick Start Guide

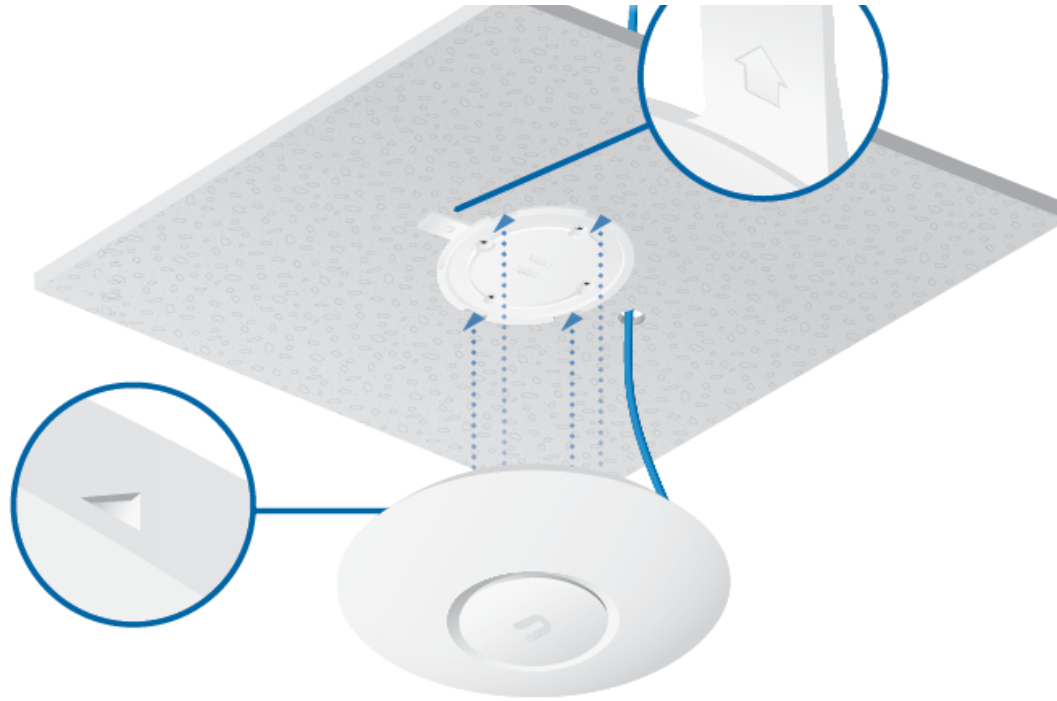

8.



UAP-nanoHD Quick Start Guide



9.



UAP-nanoHD Quick Start Guide

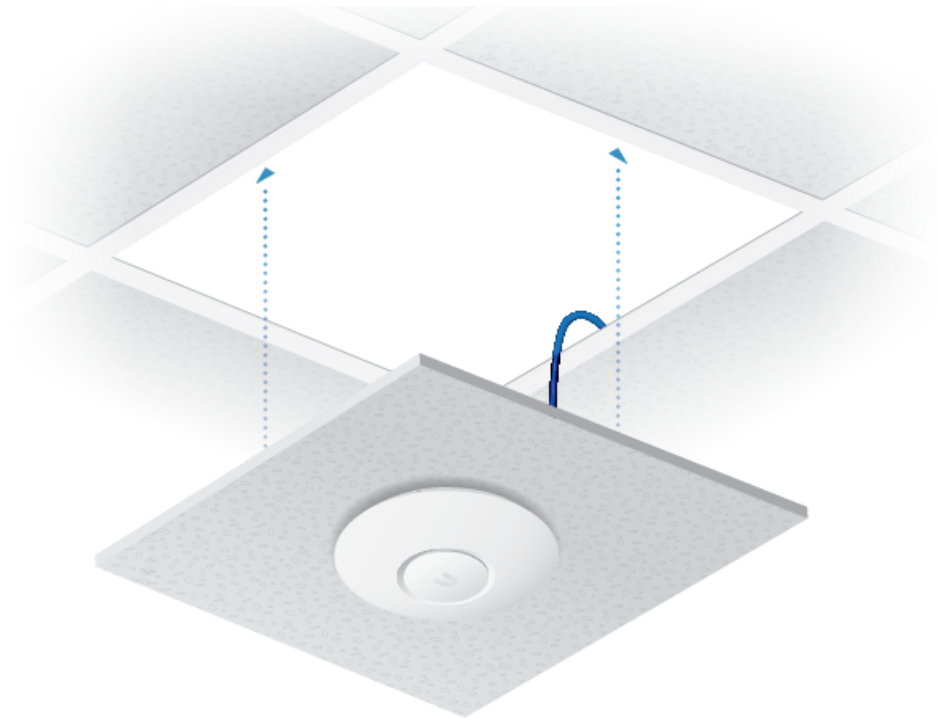

Powering the UniFi AP

The UAP-nanoHD features auto-sensing 802.3af PoE support and can be powered by any of the following:

- Ubiquiti UniFi Switch with PoE
- 802.3af PoE compliant switch
- Ubiquiti Gigabit PoE Adapter (48V, 0.3A)

The single-pack of the UAP-nanoHD includes one Gigabit PoE adapter. For multi-pack units, PoE adapters or a UniFi Switch with PoE may be purchased separately.

Connecting to a PoE Switch

UAP-nanoHD Quick Start Guide

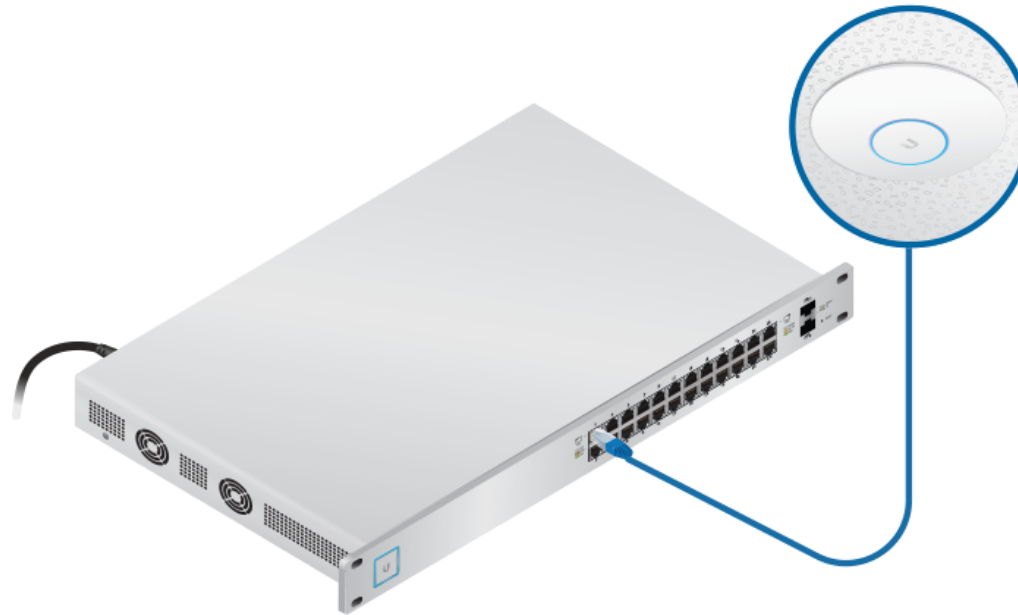

Connecting to the PoE Adapter

1. Connect the Ethernet cable from the device to the POE port of the PoE adapter.
2. Connect an Ethernet cable from your LAN to the LAN port of the PoE adapter.
3. Connect the Power Cord to the adapter, and then plug the Power Cord into a power outlet.



UAP-nanoHD Quick Start Guide

1. Remove the PoE Mounting Bracket from the adapter, place the bracket at the desired location, and mark the two holes.
2. Pre-drill the holes if necessary, and secure the bracket using two fasteners (not included).
3. Align the adapter's slots with the tabs of the PoE Mounting Bracket, and then slide the adapter down.



Software Installation

Download and install the latest version of the UniFi Controller software. Launch it and follow the on-screen instructions. The software and step-by-step instructions in the User Guide are available at: ui.com/download/unifi

After you have installed the software and run the UniFi Installation Wizard, a login screen will appear for the UniFi Controller management interface. Enter the username and password that you created and click Sign In.



UAP-nanoHD Quick Start Guide

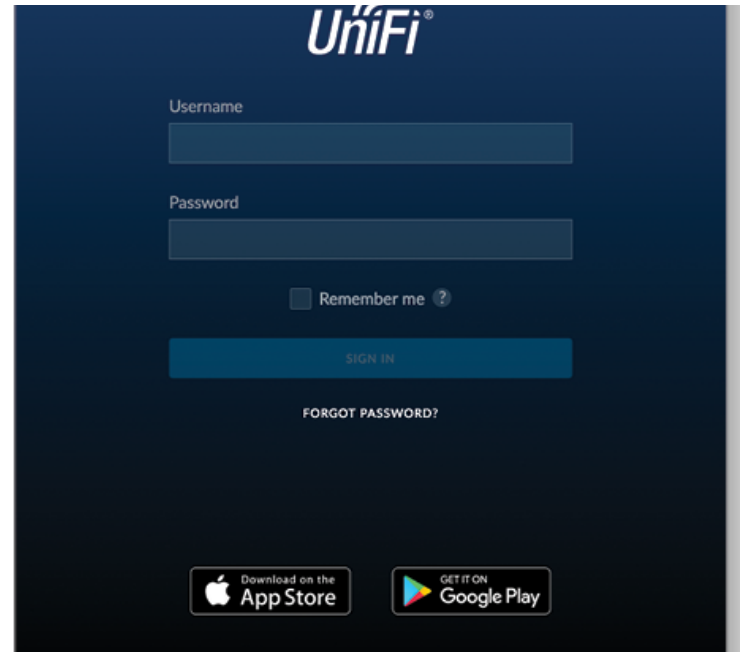

You can manage your wireless network and view network statistics using the UniFi Controller management interface. For information on configuring and using the UniFi Controller software, refer to the User Guide.

Mobile App Installation

Ubiquiti also offers the UniFi app, which is available from the App Store® (iOS) or Google Play™ Store (Android). You can use it to provision a UniFi AP for basic functionality without configuring a UniFi Controller. It also allows seamless provisioning of APs for remote controllers (controllers not on the same Layer 2 network) and easy access to local controllers and those monitored on unifi.ui.com

Specifications

UAP-nanoHD

UAP-nanoHD Quick Start Guide

Dimensions	63 x 63 x 12.9 mm (6.3 x 6.3 x 1.29")
Weight	300 g (10.6 oz)
With Mounting Kits	315 g (11.1 oz)
Networking Interface	(1) RJ45 GbE
Buttons	(1) Reset to Defaults
Power Method	802.3af
Power Supply	48V, 0.3A Gigabit PoE Adapter*
Max. Power Consumption	10.5W
Operating Frequency	2.4 GHz 5 GHz
Max. TX Power	
2.4 GHz	23 dBm
5 GHz	26 dBm
Antenna Gain	
2.4 GHz	2.8 dBi
5 GHz	3 dBi
MIMO	
2.4 GHz	2x2
5 GHz	4x4
Radio Rate	
2.4 GHz	300 Mbps
5 GHz	1733 Mbps
Wi-Fi Standards	802.11 a/b/g/n/ac/ac-wave2
Wireless Security	WEP, WPA-PSK, WPA-Enterprise (WPA/WPA2, TKIP/AES)
BSSID	8 per Radio

UAP-nanoHD Quick Start Guide

Operating Temperature	-10 to 70° C (14 to 158° F)
Operating Humidity	5 to 95% Noncondensing
Certifications	CE, FCC, IC

** Only the single-pack of the UAP-nanoHD includes a PoE adapter.*

Operating Frequency (MHz)	
US/CA	2400 - 2483.5
	U-NII-1 5150 - 5250
	U-NII-2A 5250 - 5350
	U-NII-2C 5470 - 5725
	U-NII-3 5725 - 5850
Worldwide	2400 - 2483.5
	5150 - 5875

Safety Notices

1. Read, follow, and keep these instructions.
2. Heed all warnings.
3. Only use attachments/accessories specified by the manufacturer.



WARNING: Do not use this product in location that can be submerged by water.



WARNING: Avoid using this product during an electrical storm. There may be a remote risk of electric shock from lightning.

UAP-nanoHD Quick Start Guide

1. Compliance is required with respect to voltage, frequency, and current requirements indicated on the manufacturer's label. Connection to a different power source than those specified may result in improper operation, damage to the equipment or pose a fire hazard if the limitations are not followed.
2. There are no operator serviceable parts inside this equipment. Service should be provided only by a qualified service technician.
3. This equipment is provided with a detachable power cord which has an integral safety ground wire intended for connection to a grounded safety outlet.
 - a. Do not substitute the power cord with one that is not the provided approved type. Never use an adapter plug to connect to a 2-wire outlet as this will defeat the continuity of the grounding wire.
 - b. The equipment requires the use of the ground wire as a part of the safety certification, modification or misuse can provide a shock hazard that can result in serious injury or death.
 - c. Contact a qualified electrician or the manufacturer if there are questions about the installation prior to connecting the equipment.
 - d. Protective earthing is provided by Listed AC adapter. Building installation shall provide appropriate short-circuit backup protection.
 - e. Protective bonding must be installed in accordance with local national wiring rules and regulations.

Limited Warranty

ui.com/support/warranty

The limited warranty requires the use of arbitration to resolve disputes on an individual basis, and, where applicable, specify arbitration instead of jury trials or class actions.

Compliance

FCC

Changes or modifications not expressly approved by the party responsible for compliance could void the user's authority to operate the equipment.

This device complies with Part 15 of the FCC Rules. Operation is subject to the following two conditions.

1. This device may not cause harmful interference, and

UAP-nanoHD Quick Start Guide

This equipment has been tested and found to comply with the limits for a Class A digital device, pursuant to part 15 of the FCC Rules. These limits are designed to provide reasonable protection against harmful interference when the equipment is operated in a commercial environment. This equipment generates, uses, and can radiate radio frequency energy and, if not installed and used in accordance with the instruction manual, may cause harmful interference to radio communications. Operations of this equipment in a residential area is likely to cause harmful interference in which case the user will be required to correct the interference at his own expense.

This radio transmitter has been approved by FCC.

ISED Canada

CAN ICES-3(A)/NMB-3(A)

This device complies with ISED Canada licence-exempt RSS standard(s). Operation is subject to the following two conditions:

1. This device may not cause interference, and
2. This device must accept any interference, including interference that may cause undesired operation of the device.

This radio transmitter has been approved by ISED Canada.

The device for operation in the band 5150-5250 MHz is only for indoor use to reduce the potential for harmful interference to co-channel mobile satellite systems.

CAN ICES-3(A)/NMB-3(A)

Le présent appareil est conforme aux CNR d'ISDE Canada applicables aux appareils radio exempts de licence. L'exploitation est autorisée aux deux conditions suivantes :

1. l'appareil ne doit pas produire de brouillage;
2. l'appareil doit accepter tout brouillage radioélectrique subi, même si le brouillage est susceptible d'en compromettre le fonctionnement.

Le présent émetteur radio a été approuvé par ISDE Canada.

Les dispositifs fonctionnant dans la bande 5150-5250 MHz sont réservés uniquement pour une utilisation à l'intérieur afin de réduire les risques de brouillage préjudiciable aux systèmes de satellites mobiles



UAP-nanoHD Quick Start Guide

IMPORTANT NOTE

Radiation Exposure Statement

- This equipment complies with radiation exposure limits set forth for an uncontrolled environment.
- This equipment should be installed and operated with minimum distance 20 cm between the radiator and your body.
- This transmitter must not be co-located or operating in conjunction with any other antenna or transmitter.

AVIS IMPORTANT

Déclaration sur l'exposition aux rayonnements

- Cet équipement est conforme aux limites prévues pour l'exposition aux rayonnements dans un environnement non contrôlé.
- Lors de l'installation et de la mise en fonctionnement de l'équipement, assurez-vous qu'il y ait une distance minimale de 20 cm entre l'élément rayonnant et vous.
- Cet émetteur ne doit être installé à proximité d'aucune autre antenne ni d'aucun autre émetteur, et ne doit être utilisé conjointement à aucun autre de ces appareils.

Australia and New Zealand



Warning: This equipment is compliant with Class A of CISPR 32. In a residential environment this equipment may cause radio interference.

Brazil



Nota: Este equipamento não tem direito à proteção contra interferência prejudicial e não pode causar interferência em sistemas devidamente autorizados.

UAP-nanoHD Quick Start Guide

CE marking on this product represents the product is in compliance with all directives that are applicable to it.



Country List



AT	BE	BG	CY	CZ	DE	DK	EE	EL	ES	FI	FR	HR	HU
IE	IT	LV	LT	LU	MT	NL	PL	PT	RO	SE	SI	SK	UK

BFWA (Broadband Fixed Wireless Access) members noted in blue



Note: This device meets Max. TX power limit per ETSI regulations.

The following apply to products that operate in the 5 GHz frequency range:



Note: This device is restricted to indoor use only when operating in the 5150 - 5350 MHz frequency range within all member states.



Note: All countries listed may operate at 30 dBm. BFWA member states may operate at 36 dBm.



Note: Operation in the 5.8 GHz frequency band is prohibited in BFWA member states. Other countries listed may use the 5.8 GHz frequency band.

WEEE Compliance Statement



UAP-nanoHD Quick Start Guide

Online Resources



© 2020 Ubiquiti Inc. All rights reserved.